

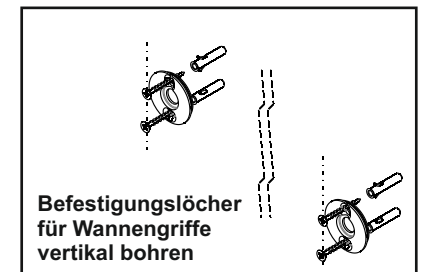

Maximale Belastung für Wannengriffe 100Kg  
(Befestigungslöcher müssen senkrecht gebohrt werden)

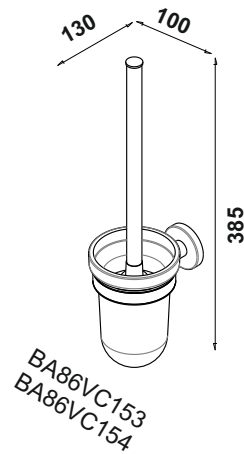

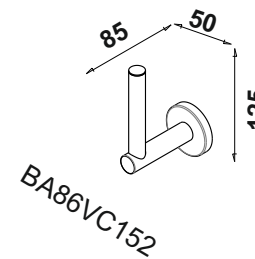
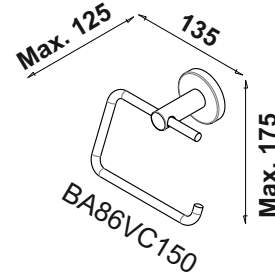
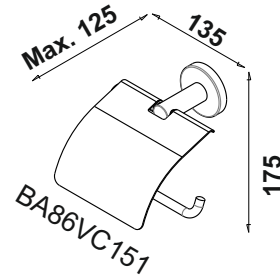
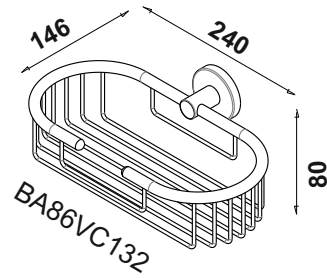
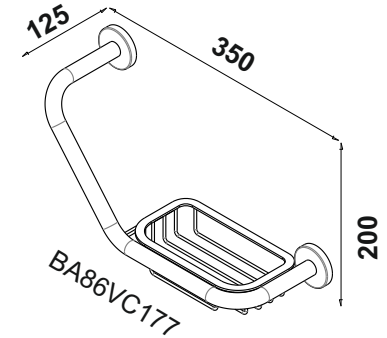
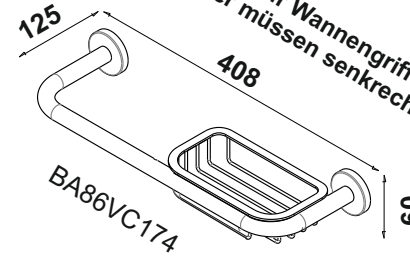
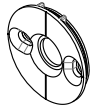

**BA86xx821**

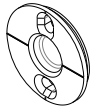

**BA86xx822**  
Wannengriffe/grab bars



**BA 81xx826**

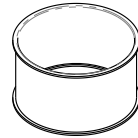

**BA86xx825**

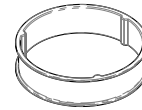

**BA 81xx827**

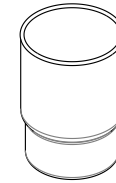

**BA19xx801**  
**BA19xx802**

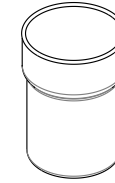

**BA86xx801**  
**BA86xx802**

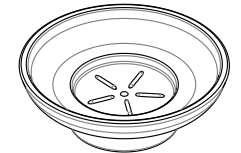

**BA81xx805**  
**BA84xx806**

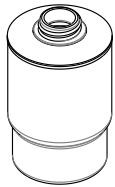

**BA56xx881**  
**BA56xx882**

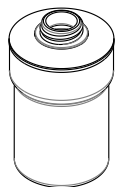

**BA86xx881**  
**BA86xx882**

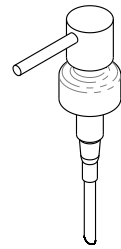

**BA56vc831**

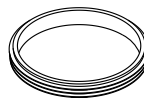

**BA56xx833**

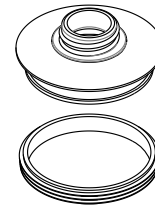

**BA56vc880**

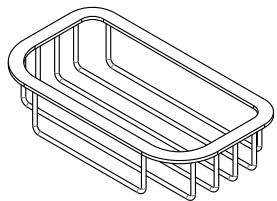

**BA40vc852**



**BA81xx830**



**BA40XX861**

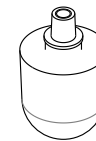

**BA40xx863**

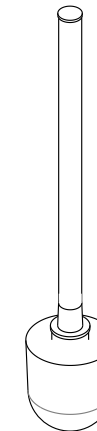

**BA40vc862**

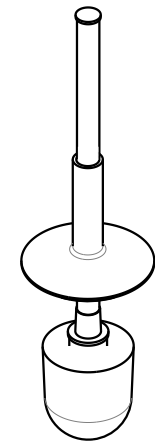

**BA40vc856**