

L-shaped shower curtain rod, adjustable, BA90VC015

Serie	Duschvorhangstangen / -schienen
Typ	Duschvorhangschienen und -stangen
Material	chrome plated
Length cm	150 x 70
Richner-Nr.	4454727
Sanitas-Troesch Nr.	1714 315 501
Team Nr.	171315 501

Produktbeschreibung

BODENSCHATZ shower curtain rod, L-shaped, 150 x 70 cm, diameter 2 cm, concealed fixing, chrome-plated brass, adjustable Ceiling support recommended

Produktabbildung



Masszeichnung

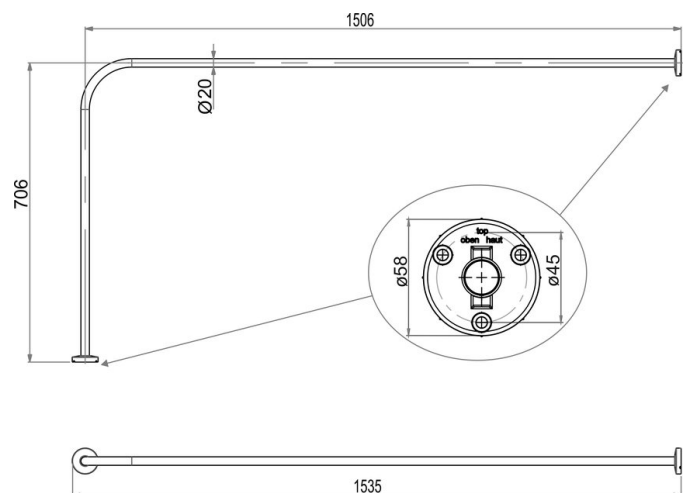

Pflegehinweise

Finden Sie unter [bodenschatz.ch/en-ch/service/reinigung-pflege/](https://www.bodenschatz.ch/en-ch/service/reinigung-pflege/)

Ersatzteile & Zubehör

BA40IN840	Set of hex socket screws
BA81XX904	Mounting set flat head screws for drilling
BA90VC036	Ceiling support for shower curtain rods
BA90VC037	Ceiling support for shower curtain rods
BA90WS053	Curtain ring for shower curtain rod
BA93WS240K	Shower curtain
BA93WS240L	Shower curtain